

SOFTWARE

Powered by LaserSoft Imaging's SilverFast®

Software plays as important role as hardware to deliver a brilliant image. The OpticFilm 120 comes with the world recognized professional film scanning software, SilverFast Ai Studio 8, and it is full functionality. For example, SilverFast iSRD® helps dust and scratch removal and optimizes images. SilverFast Multi-Exposure® increases the dynamic range and reduces noises. Auto IT8 Calibration® helps color calibrating in 2 minutes and ensures correct colors. All in all, SilverFast Ai Studio 8 meets the highest standards, and these SilverFast software features are well-combined and perfectly-integrated with the OpticFilm 120.



SilverFast Auto IT8 Calibration (patented)

get consistent colors with just two mouse clicks

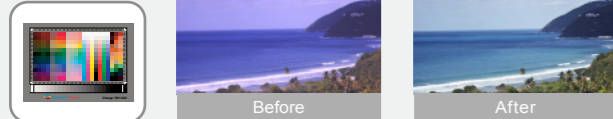

SilverFast Multi-Exposure (patented)

improves Dynamic Range and brings up more picture details; reduces noise

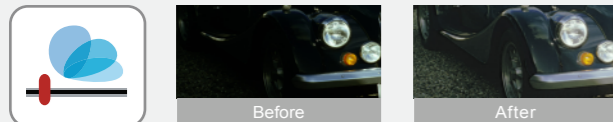

Kodachrome

enables scanning of kodachrome slides with natural colors

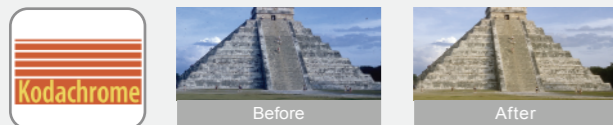

SCC (Selective Color Correction)

changes and manipulates individual colors

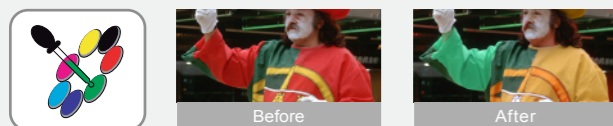

iSRD (infrared Smart Removal of Dust)

perfect, user controlled removal of dust and scratches via infrared channel



NegaFix

allows allocation and generation of film-profiles for negatives

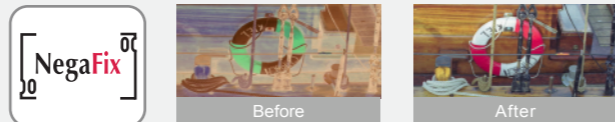

USM

excellent sharpening tool with preview of the final sharpening effect



SC2G (Selective Color to Gray)

allows distinguish different contrast levels when converting colored images into grayscale images

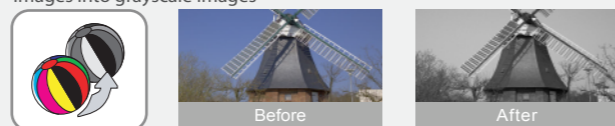

Hardware Requirements

Windows PC :
2 GHz Processor or faster
2 GB RAM main memory (4 GB RAM recommended)
10 GB free space on hard disk drive
DVD drive or internet connection

Mac :
2 GHz Processor or faster (INTEL based processor, NO PowerPC)
2 GB RAM main memory (4 GB RAM recommended)
10 GB free space on hard disk drive
DVD drive or internet connection

Specification

Image Sensor	CCD
Light Source	LED
Resolution	Maximum Optical Resolution : 5300 dpi Maximum Hardware Resolution : 10600 dpi
Scan Modes	Color: 48-bit input, 24/48-bit output Grayscale: 16-bit input, 8/16-bit output
Dynamic Range	4.01 or above
Infrared	Built-in
Scanning Area (W x L)	60 mm x 120 mm
IT8 Target	Included for color accuracy (6x7cm)
Power Supply	24 Vdc / 0.75 A
Interface	USB 2.0
Net Weight	Approx. 5.7 Kgs
Dimensions (W x D x H)	210 x 374 x 189 mm
OS	Windows XP / Vista / 7 / 8 Intel-based Mac OS X 10.5 / 10.6 / 10.7 / 10.8

Headquarters: sales@plustek.com



plustek

OpticFilm Series

OpticFilm 120

The OpticFilm 120 delivers the professional image quality results from 35mm film strips, slides, and 120/220mm film from 6x4.5cm up to 6x12cm in sizes. It is designed for professional photographers, advanced amateur photographers, film photo enthusiasts, photography schools and clubs. The OpticFilm 120 satisfies the film scanning requirements of advanced amateurs or professionals that require the ultimate in image quality and an ICC profiled scanning system.



Extraordinary image quality

The outstanding image quality is assured by state of the art optical and electronic systems including an 8-element glass lens with 5,300 dpi optical resolution, high-sensitive color CCD with 10,600 dpi resolution, and stable light sources. Delivering an effective usable Dynamic Range of 4.01 (with SilverFast Multi-Exposure®/ according to ISO 21550:2004) and a theoretically penetrable maximum density of 4.8, guaranteeing accurate color and all highlight and shadow details. Therefore the OF120 reaches a level that is only achieved by drum scanners so far.



5-group 8-element glass lens delivers incredibly sharp images.



Exceptional clarity and detail.

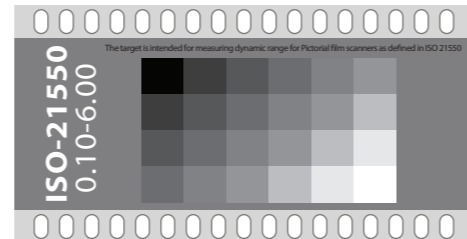

4.01 Dynamic Range as tested with ISO 21550 0-6 OD target.

Newly designed film carriers ensure accurate imaging and efficient workflow.

The OpticFilm 120 includes patent-pending, adjustable pitch 120mm film holders that ensures flat film for in-focus scans. Users do not need to cut 3-frame 6x7 120 film strips. The OpticFilm 120 also uses an automatic motorized film transport system that speeds the scanning workflow.

Dedicated 120mm film holder with adjustable pitch holds film flat.



No need to cut 3-frame 6x7 120mm film strips

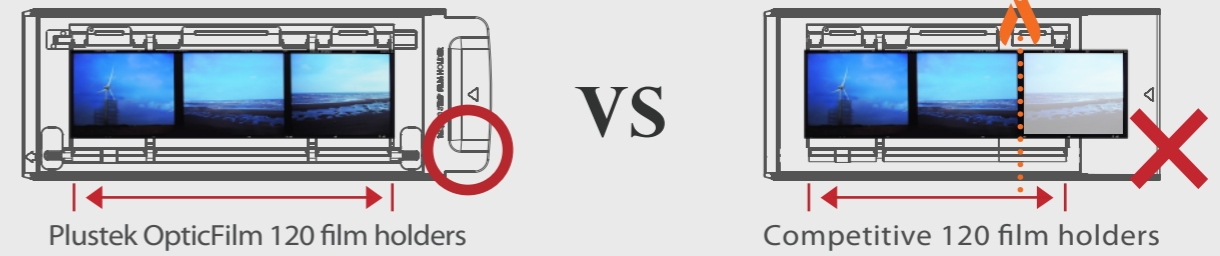

Elegant and Compact design

The OpticFilm 120's metal case provides isolation and stability for the lens, CCD and automatic transport assemblies. The OpticFilm 120 is one of the most compact 120 film scanners on the market. The rear cover design reduces the scanners overall dimensions and prevents dust from entering the scanner.



Accessories

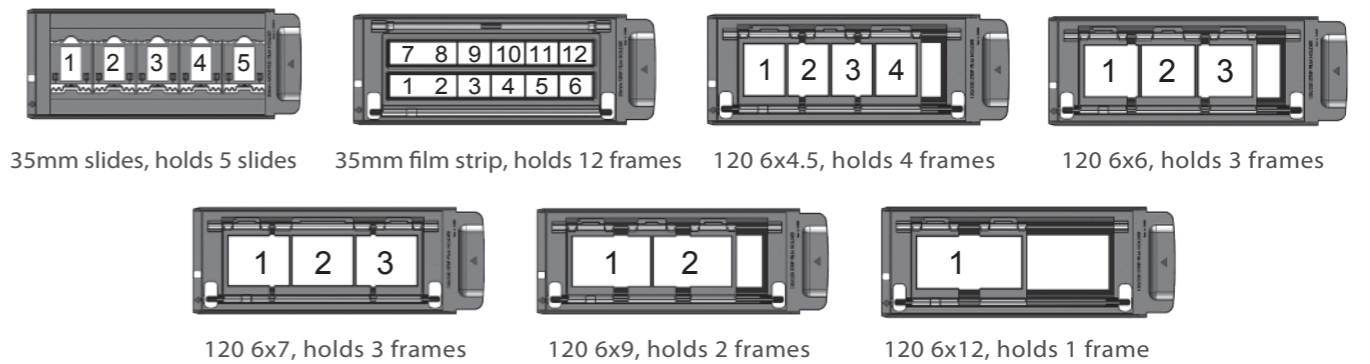

35mm slides, holds 5 slides 35mm film strip, holds 12 frames 120 6x4.5, holds 4 frames 120 6x6, holds 3 frames

120 6x7, holds 3 frames 120 6x9, holds 2 frames 120 6x12, holds 1 frame

